

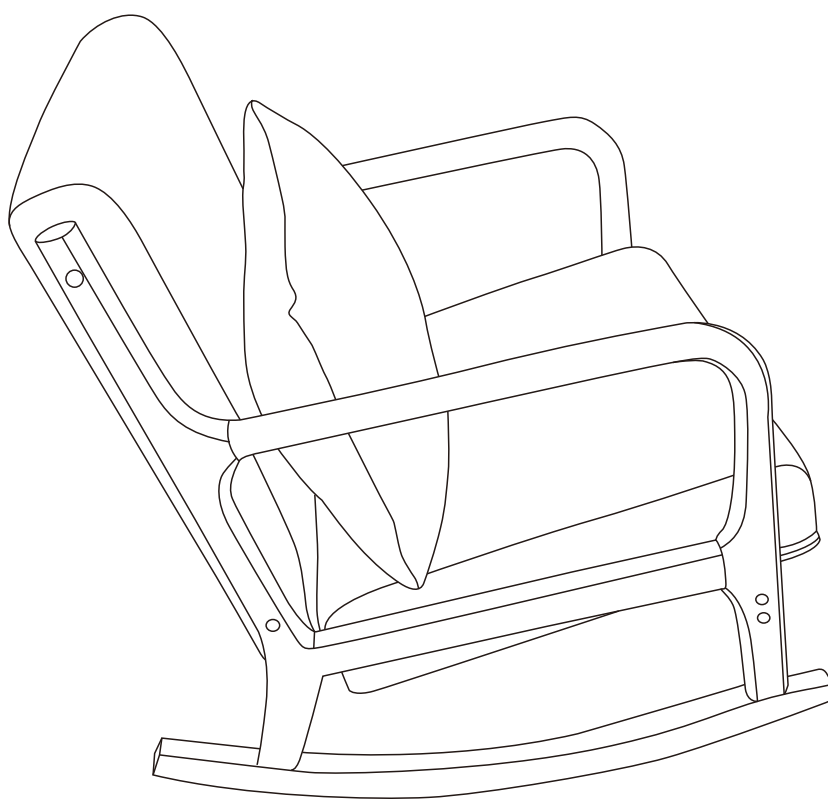







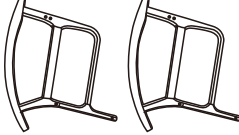

# Clinton

**1359-139801**



# 1359-139801

A		61x58x10CM	*1	1/1
B		61x57x15CM	*1	1/1
C		81x75.5x3CM	*2	1/1
D		58x6x2.5CM	*1	1/1
E		M8*35mm	*4	1/1
F		M8*70mm	*6	1/1
G		M5	*1	1/1
H		1x1. 3CM	*4	1/1
I		14mm	*8	1/1
J		62*36*12CM	*1	1/1

FR: SAV/INFORMATION/VIDEO/CONTACT

EN: AFTER-SALES SERVICE/INFORMATION/VIDEO/CONTACT

DE: REPARATUR-SERVICE UND ERSATZTEILE /INFORMATIONEN/VIDEO/KONTAKT

ES: SERVICIO POST-VENTA/INFORMACIÓN/VIDEO/CONTACTO

IT: SERVIZIO ASSISTENZA/INFORMAZIONI/VIDEO/CONTATTO

PT: SERVIÇO PÓS-VENDA/INFORMAÇÕES/VIDEO/CONTATO

PL: SERWIS TECHNICZNY/INFORMACJE/WIDEO/KONTAKT

NE: AFTER SALES SERVICE/INFORMATIE/VIDEO/CONTACT

HE: לאחר שירות ומכירות/מידע /הווידאו/לתקשר עם

SAV.HABITATETJARDIN.COM

